



Mobile FumeKART

Fume Extraction System

User Manual

Installation, Operation, and Service Information

Donaldson
BOFA™



This manual contains specific precautions related to worker safety. The hazard alert image denotes safety related instructions and warnings in this manual. DO NOT install, operate, or perform maintenance on this system until you have read and understood the instructions, precautions and warnings contained within this manual.

English
Original Instructions

UM-MOBILE FUMEKART-BOFA-US
Revision 1.1

Donaldson BOFA Technical Service

If a problem arises with your system, please refer to the troubleshooting section of this manual. If the problem is still not resolved, please:

- Visit our website at donaldsonbofa.com for online help.
- Or contact the helpline:
 - ROW: +44 (0) 1202 699 444 (Mon-Fri 9am-5pm GMT)
 - US: +1 (618) 205 5007 (Mon-Fri 9am-5pm CST).
- Email:
 - ROW: bofatechnical@donaldson.com
 - US: bofatechnicalus@donaldson.com

Serial Number

For future reference, fill in your system details in the space provided. The serial number is on the rating label located on the side/rear of the system.

Table of Contents

1	Overview.....	4
1.1.	Front view of Mobile FumeKART	4
1.2.	Rear view of Mobile FumeKART	5
1.3.	Overview of control panel	6
2	Safety information	7
2.1.	Important safety notes	7
2.2.	Warning and information labels	8
2.3.	Fire risk warning	9
3	Before installation	10
3.1.	Packaging removal and system placement	10
4	Installation	11
4.1.	Connection to extraction system	11
4.2.	Connection to power supply	11
5	Operation	12
5.1.	Turning extraction system on	12
5.2.	Setting the desired airflow	12
5.3.	To set the airflow	12
5.4.	Warm-up	13
6	Maintenance.....	14
6.1.	Maintenance UK	14
6.1.1.	Maintenance general	14
6.1.2.	Cleaning the extraction system	14
6.2.	Filter information	14
6.2.1.	Filter replacement	14
6.2.2.	VOC sensor option	15
7	Troubleshooting.....	16
7.1.	Fault indication	16
8	Replacement parts.....	17
8.1.	Consumable spares	17
8.2.	Maintenance protocol	17
8.3.	Filter disposal	17
9	System specifications	18
10	Contact information.....	19
11	Inspection record.....	20

1 Overview

1.1 Front view of Mobile FumeKART

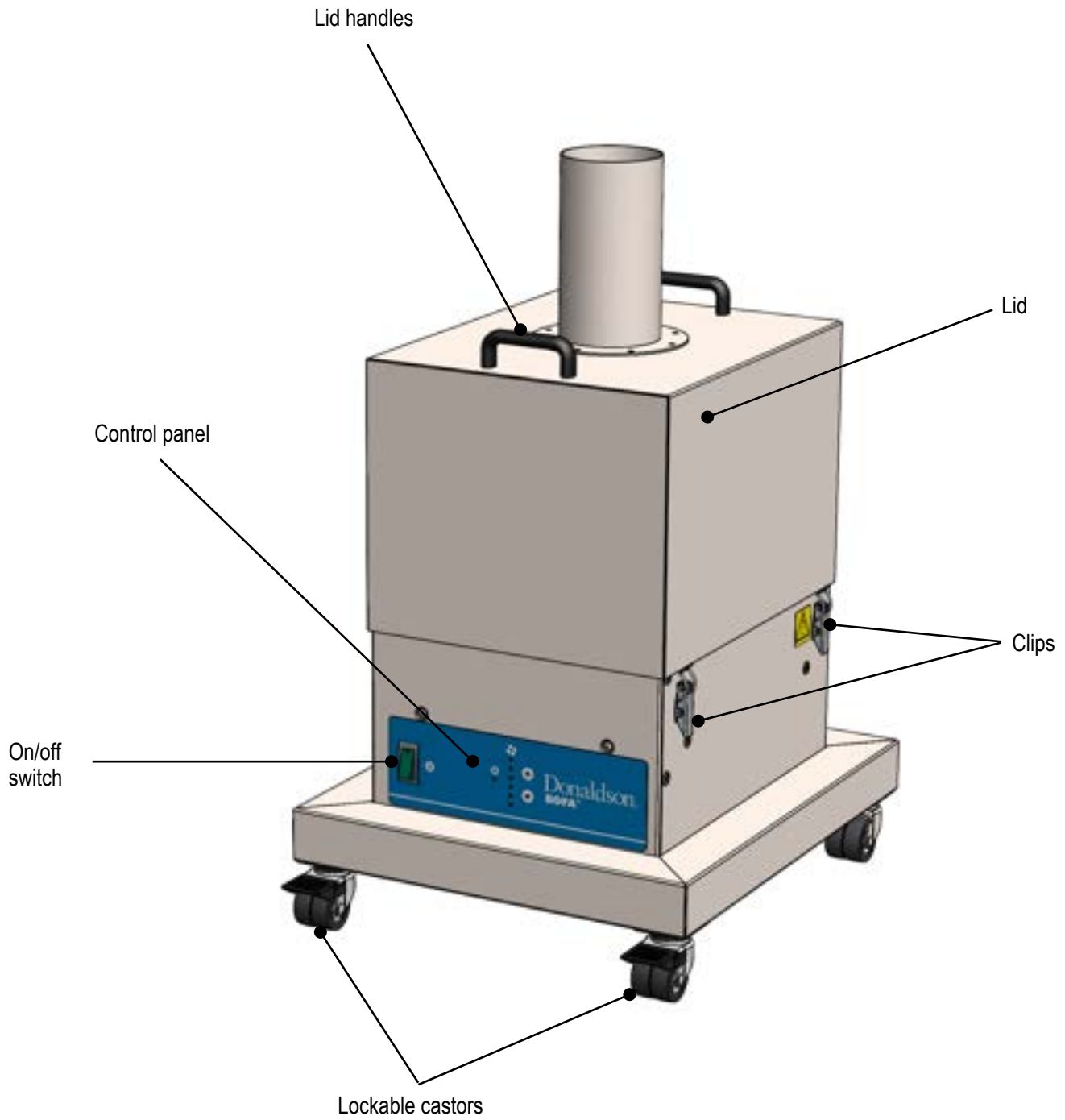

1.2. Rear view of Mobile FumeKART

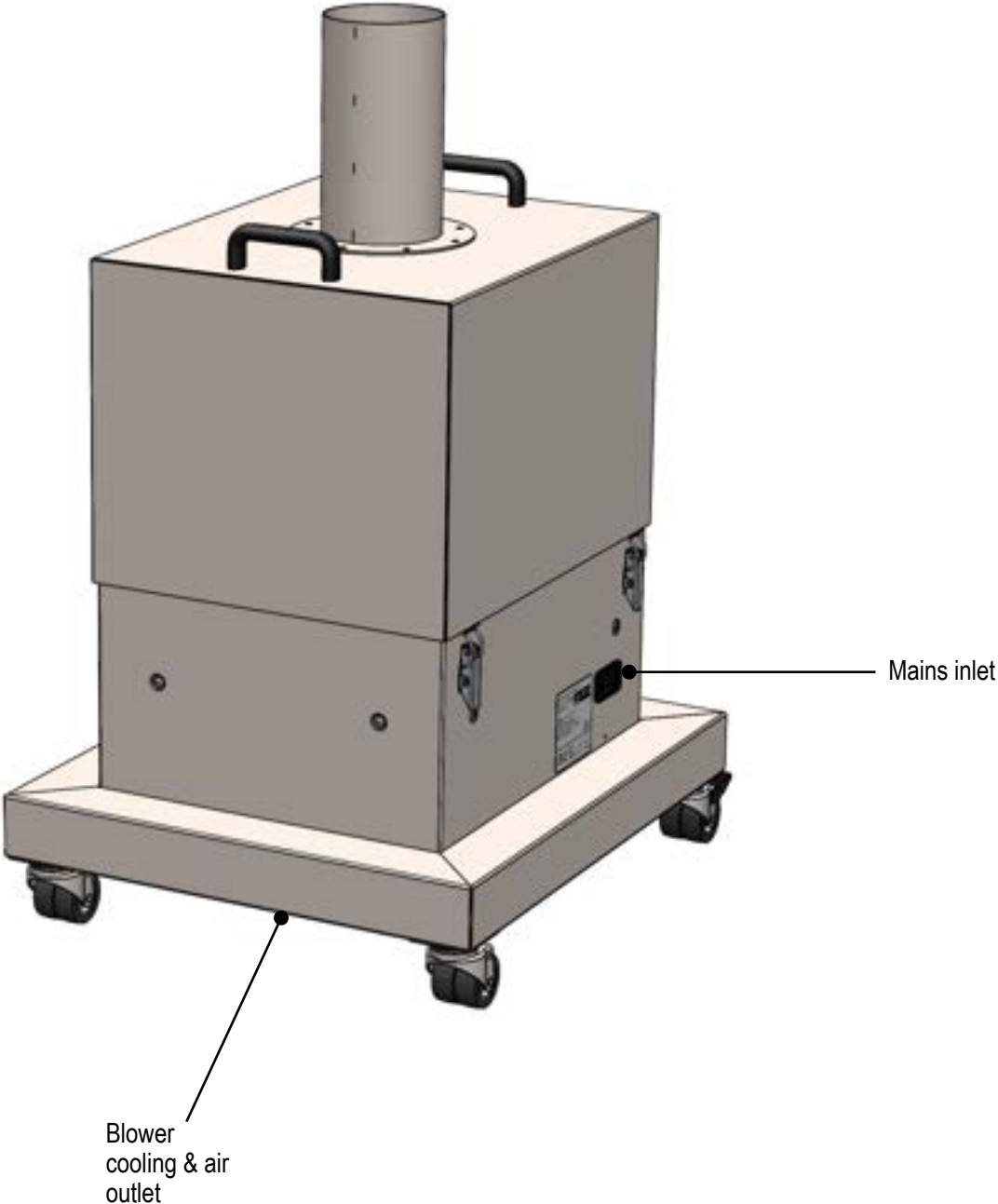

1.3. Overview of control panel



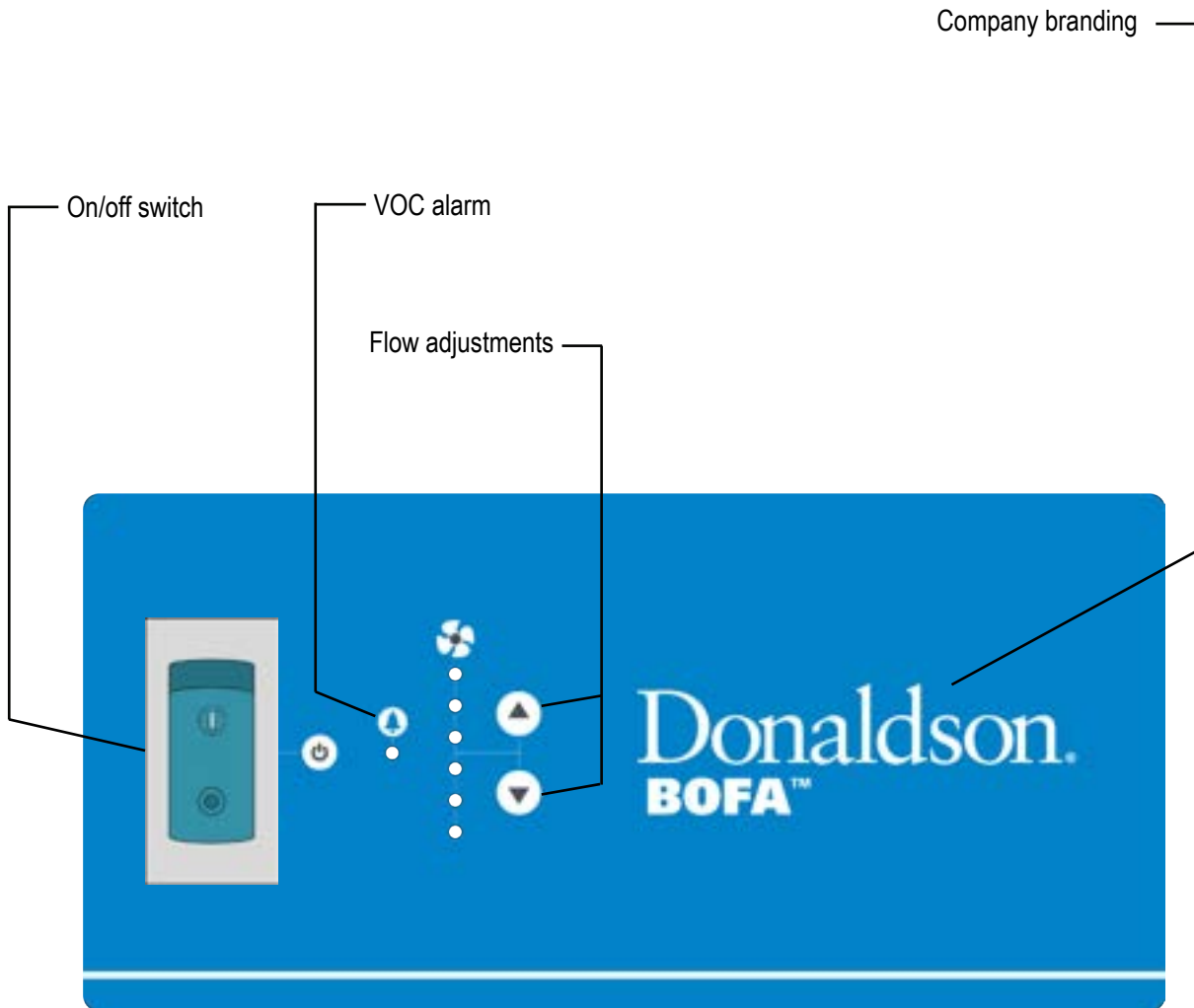

The diagram below shows an overview of control panel features.



2 Safety information

2.1 Important safety notes

Concerning symbols used on the extraction system and referred to within this manual.

Symbol	Meaning	
	DANGER	Refers to an immediately impending danger. If the danger is not avoided, it could result in death or severe (crippling) injury. Please consult the manual when this symbol is displayed.
	WARNING	Refers to a possibly dangerous situation. If not avoided, it could result in death or severe injury. Please consult the manual when this symbol is displayed.
	CAUTION	Refers to a possibly harmful situation. If not avoided, damage could be caused to the product or something in its environment.
	IMPORTANT (refer to manual)	Refers to handling tip and other particularly useful information. This does not signify a dangerous or harmful situation. Refer to manual when this symbol is displayed.

EU Declaration

The system has been designed to meet the essential health and safety requirements of the Machinery Directive 2006/42/EC, Low Voltage Directive 2014/35/EC, and the EMC Directive 2014/30/EU. For the full DOC and further information please contact the technical team:

- US: bofatechnicalus@donaldson.com
- ROW: bofatechnical@donaldson.com

Electrical safety

The system has been designed to meet the essential health and safety requirements of the Low Voltage Directive 2014/35/EC. The requirements of the EMC Directive 2014/30/EU are also met.

Warning

When working with the blower housing open, live 230/115 volt mains components are accessible. Ensure that the rules and regulations for work on live components are always observed.

Important

To reduce the risk of fire, electric shock, or injury:

1. Always isolate the system from the mains power supply before removing the blower access panel.
2. Use only as described in this manual.
3. Connect the system to a properly grounded outlet.

Dangers to eyes, breathing, and skin

Once used, the filters within the extraction system may contain a mixture of particulates, some of which may be sub-micron size. When the used filters are moved, it may agitate some of this particulate, which could get into the breathing zone and eyes of the operative.

Additionally, depending on the materials being processed, the particulate may be an irritant to the skin.

This system should not be used on processes with sparks of flammable materials or with explosive dusts and gases, without implementation of additional precautions.

	CAUTION	When changing used filters, always wear a mask, safety shoes, goggles, and gloves.
---	---------	--

Carbon selection



Please note that the media within the gas filter fitted in the extraction system is capable of adsorbing a wide range of organic compounds. However, it is the responsibility of the user to ensure it is suitable for the particular application it is being used on.

Intended use

This equipment has been designed to extract and filter fume from a variety of applications. However, it is the user's responsibility to ensure the equipment is installed correctly and is suitable for the application. This extraction system must not be used on wet applications or acidic fumes.

2.2. Warning and information labels

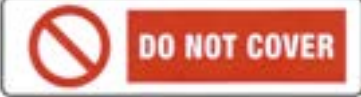
The following listing details labels used on your system.

Symbol	Meaning	
	GOGGLES, GLOVES AND MASK	This appears on filters, indicating that goggles, gloves, and masks should be worn while handling used filters.
	DO NOT COVER	Do not cover any louvers or holes on panels adjacent to the label.
	ELECTRICAL DANGER	Removal of panels with this label attached will allow access to potentially live components.
	WARNING	Power should be isolated before the panel with this label attached is opened/removed.

PLEASE NOTE: If the equipment is used in a manner not specified by the manufacturer, the protection provided by the equipment may be compromised.

2.3. Fire risk warning

In the very rare event that a burning ember or spark is drawn into the fume extraction system, it may be possible that the filters will ignite. Whilst any resultant fire would typically be retained within the fume extraction system, the damage to the extraction system could be significant.

It is therefore essential to minimize the possibility of this occurring by undertaking an appropriate risk assessment to determine:

- a). Whether additional fire protection equipment should be installed.
- b). Appropriate maintenance procedures to prevent the risk of build-up of debris which could potentially combust.

This extraction system should not be used on processes where sparks could occur, with explosive dusts and gases, or with particulates that can be pyrophoric (can spontaneously ignite), without implementation of additional precautions. It is essential that nozzles or other extraction/fume capture devices and hoses/pipework are cleaned regularly to prevent the build-up of potentially ignitable debris.

3 Before installation

3.1 Packaging removal and system placement

Before installation, check the extraction system for damage.

All packaging must be removed before the system is connected to the power supply.

Please read all instructions in this manual before using this extraction system.

1. Move the system to the location where it is going to be installed and remove the outer packaging.
This system should be installed in a well-ventilated area.
2. Ensure that 20" (500 mm) space is available around any vented panels on the extraction system to ensure adequate airflow.
3. With the system in position, lock the front two castors.
4. Check the filter is located in its correct position before replacing the lid and securing the clips.

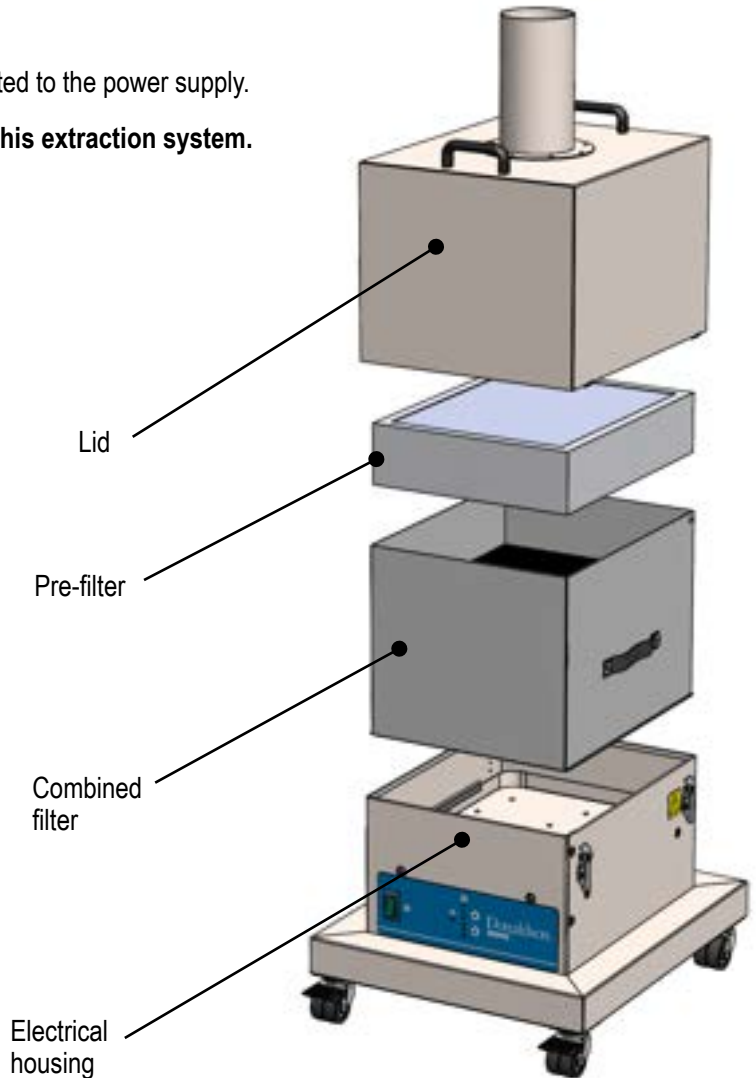

	<p>CAUTION</p>	<p>Due to the weight of the extraction system, suitable lifting equipment should be used and appropriate safety precautions taken (see system specification section for product weight detail).</p>
	<p>CAUTION</p>	<p>Do not block or cover the cooling vents on the extraction system as this severely restricts airflow and may cause damage to the system.</p>
	<p>CAUTION</p>	<p>Under no circumstances should the exhaust outlet/s be covered as this will restrict the airflow and cause overheating.</p>
	<p>CAUTION</p>	<p>Do not use the two handles to carry the complete system. These handles are intended for lifting and transporting the lid only.</p>

4 Installation



The system has been designed to remove and filter fume containing potentially hazardous particulate generated during manufacturing processes. Such hazardous substances are captured within the filtration system after which the cleaned air is returned to the workplace.

4.1. Connection to extraction system

All ductwork should be installed and connected to the extraction system before it is turned on.

4.2. Connection to power supply

Please follow the specification at the rear of the manual when selecting the power supply outlet for the system. Ensure the power supply is suitable before connecting the system.

	ELECTRICAL DANGER	Check the integrity of the electrical power cable. If the supply cord is damaged, the extraction system should not be connected to the mains. The supply cord should only be replaced by a Donaldson BOFA engineer as an electrical safety test may be required after replacement.
	CAUTION	The system MUST be connected to a properly earthed outlet.

Portable appliance testing guidance

This appliance is a Class I electrical product that requires earth protection. The appliance contains Type 3 SPDs (surge protection devices). During PAT Testing, test voltage L-E and N-E must be limited to 250 VDC to avoid engaging the surge protection.

5 Operation

5.1. Turning extraction system on

The on/off switch must be switched to the “on” position (refer to section 1 for switch location) by depressing the (I) side of the switch.

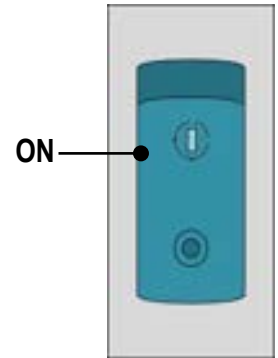

Powder-coated

5.2. Setting the desired airflow

The system features variable airflow speed. This enables the user to set the required airflow rate. Over time, as the filters begin to block, the user should manually increase the blower speed to ensure the correct flow is maintained to compensate for any loss in performance caused by the added restriction of the partially blocked filters.



IMPORTANT
(refer to manual)

The extraction system and all pipework must be fully installed and connected before the airflow is set.

5.3. To set the airflow

Press the up button to increase airflow and press the down button to decrease airflow. The level of airflow is indicated by the vertical row of six blue LEDs to the right of the mains isolation switch. As the airflow increases, more blue LEDs light up and the opposite for decreasing the airflow.

Increase airflow

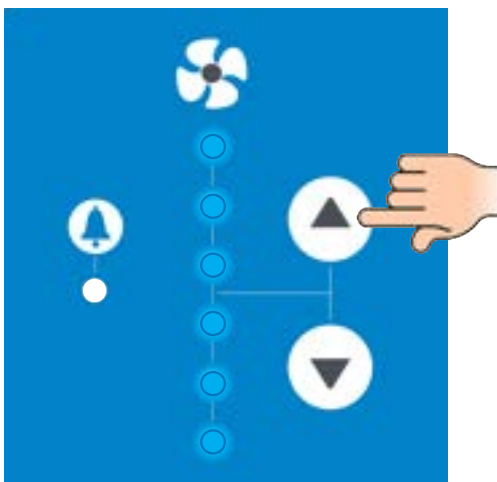

Decrease airflow

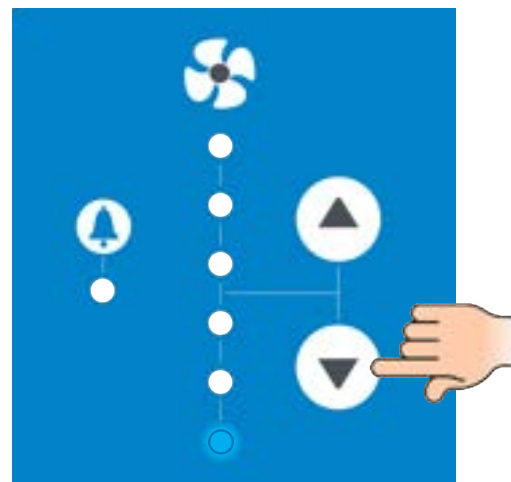

5.4. Warm-up

If your extraction system was ordered with a VOC sensor, then it is normal for the red alarm LED to flash for a few minutes when the system is first turned on. This is the VOC sensor warming up.

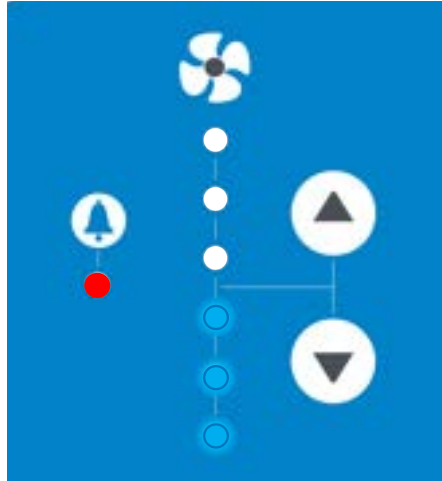

6 Maintenance

6.1 Maintenance UK

It is a legal requirement, under regulation 9 of the COSHH regulations, that all local exhaust ventilation systems are thoroughly examined and tested at least once every 14 months (typically carried out annually). The approved code of practice recommends that a visual check should be carried out at least once a week.

COSHH requires the annual inspection and testing to be carried out by a competent person and specifies that documentation results are recorded in a log.

Contact the seller for more information about inspection and certification.

6.1.1 Maintenance general

User maintenance is limited to cleaning the system and filter replacement, only a suitably qualified or experienced personnel are authorized to carry out component testing and replacement. Unauthorized work or the use of unauthorized replacement filters may result in a potentially dangerous situation and/or damage to the extraction system and will invalidate the manufacturer's warranty.

6.1.2 Cleaning the extraction system

The powder-coated finish can be cleaned with a damp cloth and non-aggressive detergent, do not use an abrasive cleaning product as this will damage the finish.

The cooling inlets and outlets should be cleaned once a year to prevent build-up of dust and overheating of the extraction system.

6.2 Filter information

It is recommended to replace filters every 12 months, unless the system prompts for more frequent changes. Users should maintain a record of these replacements.

It is recommended that a spare set of filters are kept on-site to avoid prolonged extraction system unavailability. Part numbers for replacement filters can be found on the filters fitted in your system.

To prevent overheating, extraction systems should not be run with a blocked filter condition, or with dust obstruction of inlets/outlets.

6.2.1 Filter replacement

Refer to section 2.2 for PPE requirements.

During use, the system will alert the user when its filter needs replacing. When the filter needs to be changed, the LED below the bell symbol will flash red.

To remove and replace the filter, follow the procedure detailed below.

1. Isolate the electrical supply to the extraction system.
2. Undo the four clips on the sides of the system and remove the lid using the two handles.
3. Using the two strap handles on the sides of the filter, lift the filter out of the system. Once removed, it is recommended that the used filters are bagged and sealed.
4. Lower the new filter into position.
5. Replace the lid, and fasten the four clips.

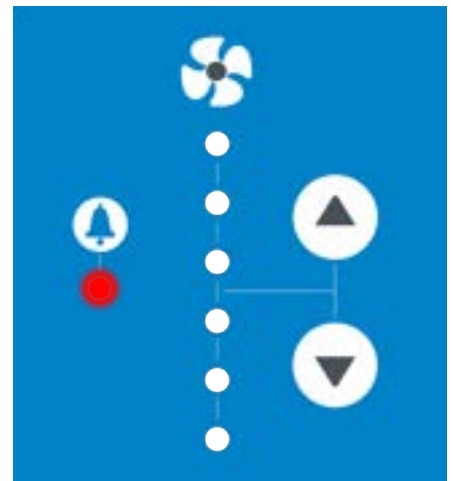

6.2.2. VOC sensor option

If the VOC sensor option is installed in your system, the extraction system will monitor and detect the level of VOC particles in the air. If the VOC level rises above a pre-set level then the LED below the bell symbol will flash red. This requires the replacement of the filter.

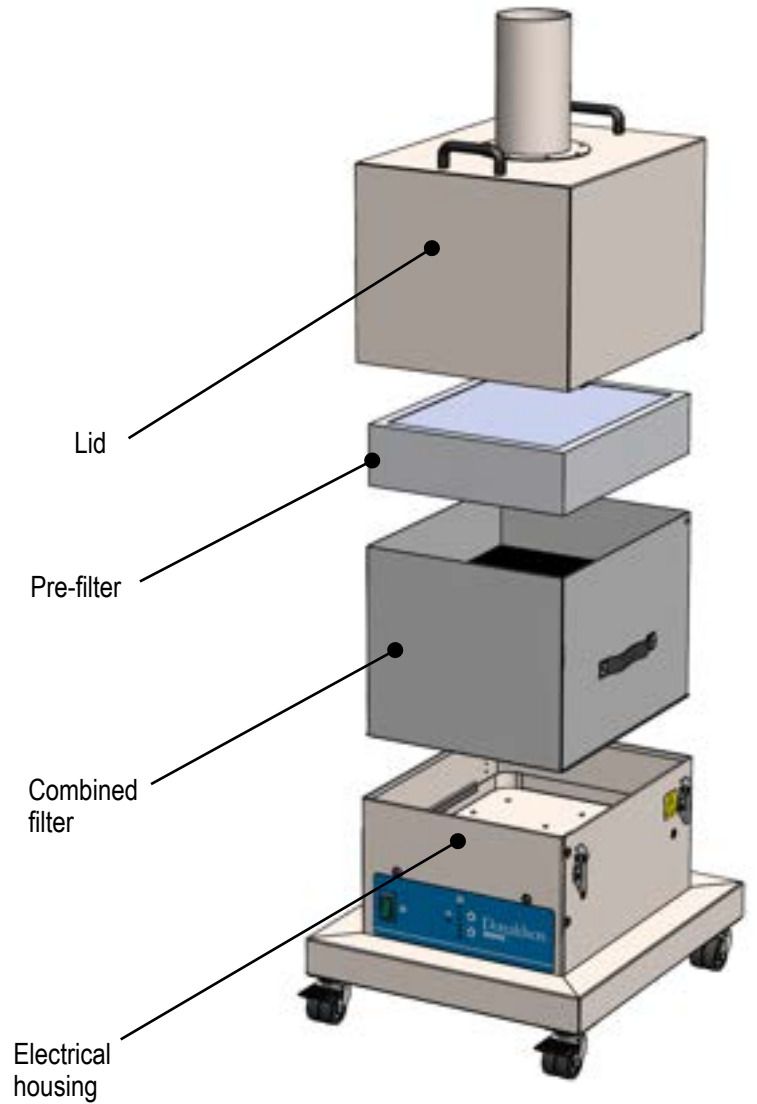
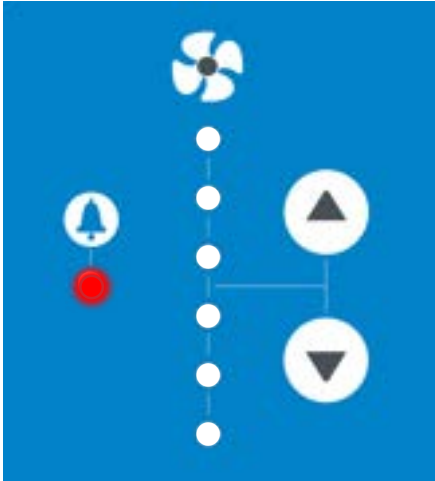

The filter **MUST** be fitted when the extraction system is in use.

7 Troubleshooting

7.1. Fault indication

In the unlikely event of any other issues with the extraction system, please contact your local representative.

8 Replacement parts

8.1. Consumable spares

The extraction system contains a pre-filter and a combined filter. These should be replaced when instructed to do so by the system (see maintenance section for replacing filters), when the extraction system is not performing efficiently, or at least once every 12 months.

To maintain performance, it is important that the filters are replaced with identical Donaldson BOFA filters. To reorder, please refer to the filter number printed on the filter installed in your extraction system. See part numbers below:

1. 1UA1030167 (pre-filter)
2. 1UA1030166 (combined filter)

8.2. Maintenance protocol

Users can record changes in filter change intervals on the table below.

Extraction System Serial Number:			
Pre-filter (1UA1030167)		Combined filter (1UA1030166)	
Date	Engineer	Date	Engineer

8.3. Filter disposal

The pre-filter and combined filter are manufactured from non-toxic materials. Filters are not reusable, cleaning used filters is not recommended. The method of disposal of the used filters depends on the material deposited on them.

For your guidance:

Deposit	EWC* Listing	Comment
Non-hazardous	15 02 03	Can be disposed of as non-hazardous waste.
Hazardous	15 02 02M	The type of hazard needs to be identified and the associated risks defined. The thresholds for these risks can then be compared with the amount of material in the filters to see if they fall into the hazardous category. If so, the filters will need to be disposed of in line with the local/national regulations.

*European Waste Catalogue

9 System specifications

Extraction system: **Mobile FumeKART**

Flowrate: 223 cfm (380 m³/h)

Weight: 119 lbs (54 kg)

Blower: Centrifugal fan

Noise level: Below 64 dB(A) (at typical operating speed)

Maximum altitude: 2000 m

Electrical supply: 115-230 V

Hertz: 50/60 Hz

Full load current: 12.5 A

No. of phases: 1

Indoor use only

Overvoltage category II

Pollution degree 2

Not for use in wet applications

Environmental operating range:

Temperature: +41 °F (5°C) to + 104 °F (40°C)

Humidity: Max 80% RH up to 87.8 °F (31°C)

Max 50% RH at 104 °F (40°C)

Size:

	Imperial (inches)	Metric (mm)
Height	33.1	840
Width	18.7	475
Depth	21.7	550

Filters:

Filter type	Surface area	Efficiency
Pre-filter	33.4 sq ft (3.1 m ²)	95% @ 0.9 microns
Combined filter	36.1 sq ft (3.4 m ²)	99.997% @ 0.3 microns

Combined filter (gas section):

Filter type	Carbon type	Volume
Combined filter (gas)	Activated carbon	19 ltr

Process fume/gas entering this system should be within the above temperature range.

Wiring schematic and spare parts list available upon request.

10 Contact information

Donaldson BOFA head office – UK & ROW:

19-20 Balena Close
Creekmoor Industrial Estate
Poole
Dorset
BH17 7DU
United Kingdom

Tel. +44 (0) 1202 699 444
Email: bofasales@donaldson.com

Donaldson BOFA German office:

Email: bofavertrieb@donaldson.com

Donaldson BOFA US office:

303 S Madison Street
Stanton, Illinois
62088 USA

Tel. +1 (618) 205 5007
Email: bofasalesus@donaldson.com

11 Inspection record



Inspection Record Local Exhaust Ventilation System

Health & Safety at Work Act 1974 - Control of Substances Hazardous to Health - Regulation 9 (2002) Thorough Examination and Testing of Local Exhaust Ventilation Systems

Company:	System Designation:	System Installation Date:
Designated Person:		

Inspection and Maintenance Schedules

1. Daily checks.
2. Weekly inspection of process enclosure, extract offtake, hose/ducting, and extraction system.
3. Monthly inspection of process enclosure, extract offtake, hose/ducting, and extraction system.
4. Yearly inspection/testing.

Process enclosure, extract offtake(s), hose/ducting, and extraction system.

Inspection and Maintenance Record

1. Daily inspection

Inspection of the process to ensure extract devices/nozzles/enclosures/hoses are in place and correctly positioned. Examination of the extraction system to ensure it is running. This to be carried out by the operator. Daily inspection not recorded.

2. Weekly inspection

Weekly inspection by supervisor of physical condition of extract devices/nozzles/enclosures/hoses and extraction system for damage, change (parts added or removed) and correct operation, etc. Check also that daily inspections have been completed. Tick boxes to confirm system ok/change. Add details of any changes.

Report changes to Engineering Manager. Record any remedial actions taken.

Week number	Date	System ok	System change	Details of change/repairs, etc.	Initial
1					
2					
3					
4					
5					
6					
7					
8					
9					
10					
11					
12					
13					
14					
15					
16					
17					
18					
19					
20					
21					
22					
23					
24					
25					

Weekly inspection by supervisor of physical condition of extract devices/nozzles/enclosures/hoses and extraction system for damage, change (parts added or removed) and correct operation, etc. Check also that daily inspections have been completed. Tick boxes to confirm system ok/change. Add details of any changes.

Report changes to Engineering Manager. Record any remedial actions taken.

Week number	Date	System ok	System change	Details of change/repairs, etc.	Initial
26					
27					
28					
29					
30					
31					
32					
33					
34					
35					
36					
37					
38					
39					
40					
41					
42					
43					
44					
45					
46					
47					
48					
49					
50					
51					
52					

Process enclosure, extract offtake(s), hose/ducting, and extraction system.

Inspection and Maintenance Record

3. Monthly inspection

In addition to weekly checks, disconnect hoses and check for blockage and smooth operation of fan, signs of dust or vapor/gas/odor carry over. Tick boxes to confirm system ok/change. Add details of any changes. Report changes to Engineering Manager. Record any remedial actions taken.

Week number	Date	System ok	System change	Details of change/repairs, etc.	Initial
1					
2					
3					
4					
5					
6					
7					
8					
9					
10					
11					
12					

4. Yearly inspection

	Comments	Supervisor signature:	Date:
Annual service to include all regular checks, inspection of filter condition, blower, and electrical system, and a filter replacement (if not changed within the previous 12 months).			
Annual thorough inspection and testing of LEV system in accordance with C.O.S.H.H. regulation 9 (max interval 14 months) including reporting.			