

NEDERMAN EXTRACTION ARM NEX HD



TECHNICAL SPECIFICATION

Installation	Indoor
Fume temperature	Max. 120 °C
Extraction arm diameter	200 mm
Airflow	1900 m ³ /h
Colour	Blue
Noise Level	66 Db(A)

FEATURES

- Arm is suspended by a robust swivel, which allows the product to rotate 360 degrees
- Flexible in all directions, perfectly balanced and very simple to position
- Support mechanism of the arms are encapsulated which protects against dirt
- Can be mounted in combination with different brackets, extension arms or on exhaust rails

DESCRIPTION

The Nederman NEX HD welding fume and dust extraction arms are the top of the range arms when it comes to high airflows and extraction of fume and dust with higher temperatures than normal.

The extraction arms are specially designed for working environments with very heavy smoke, vapours and non explosive dust.

Typical workplaces are the metal fabrication industry or other type of industries where the need for extraction with large airflows is needed.

The applications can be welding, laser or hand plasma cutting, metal spraying, grinding where lots of spatter is generated, or other industrial processes where a perfect balanced and easily positioned arm is required.

The NEX HD welding fume and dust extraction arm is also available with a patented hood design. The hood, made of aluminium, is resistant to high temperatures of extracted air (+ 120 °C) and has a very high capturing capacity. The NEX HD model is ideal for heavy duty welding and where high airflows are demanded. The arm is available in four lengths; 2 - 5 m (6.6 - 16 ft).

PRESSURE DROP GRAPH

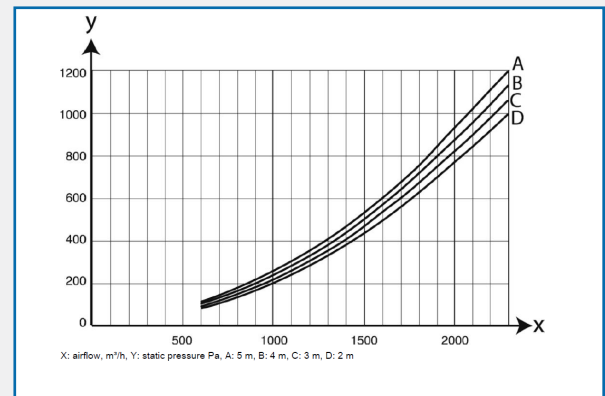

DIMENSIONS - MOUNTING

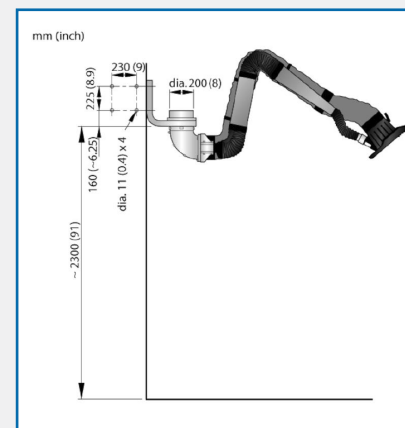

AES OFFER INSTALLATION AND SERVICE SUPPORT FOR ALL EQUIPMENT

NEDERMAN EXTRACTION ARM NEX HD

TECHNICAL SPECIFICATION

Arm Length (m)	Weight (kg)	Part No.
2	17	10560232
3	21	10560332
4	28	10560432
5	33	10560532





ACCESSORIES FOR EXTRACTION ARM NEX HD

Image	Accessory	Part No.
	LED Spotlight/fan switch Nex HD	10376903
	Fan switch Nex HD	10512532
	Spark protection for NEX HD	10512632
	Transformer 230/250 V to 24 V 25 VA	10363189
	Transformer 230/250 V to 24 V 75 VA	10361560

AES OFFER INSTALLATION AND SERVICE SUPPORT FOR ALL EQUIPMENT

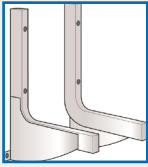
NEDERMAN EXTRACTION ARM NEX HD

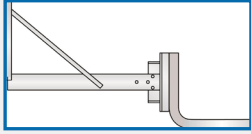
ACCESSORIES FOR EXTRACTION ARM NEX HD

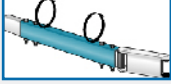
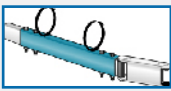
Image	Accessory	Part No.
	Wall bracket for fume extractor, 2 m, 3 m	10372215
	Wall bracket for 4-5 m NEX arms	10372722
	Airflow indicator 500-4500 Pa	10375373
	Airflow indicator 40-600 Pa	10375374
	Support 1m Nex	10512732
	Support 2m Nex	10512832
	Kit extension NEX MD/HD 1 m	10510332
	Kit extension NEX MD/HD 2 m	10510432

AES OFFER INSTALLATION AND SERVICE SUPPORT FOR ALL EQUIPMENT